

B 旋轉搬運小坦克

- 適用於窄小空間搬運。
- 可360°迴轉。

Roller Skate with Turn Table

- ※ Easy working in narrow space.
- ※ 360 degrees rotations.

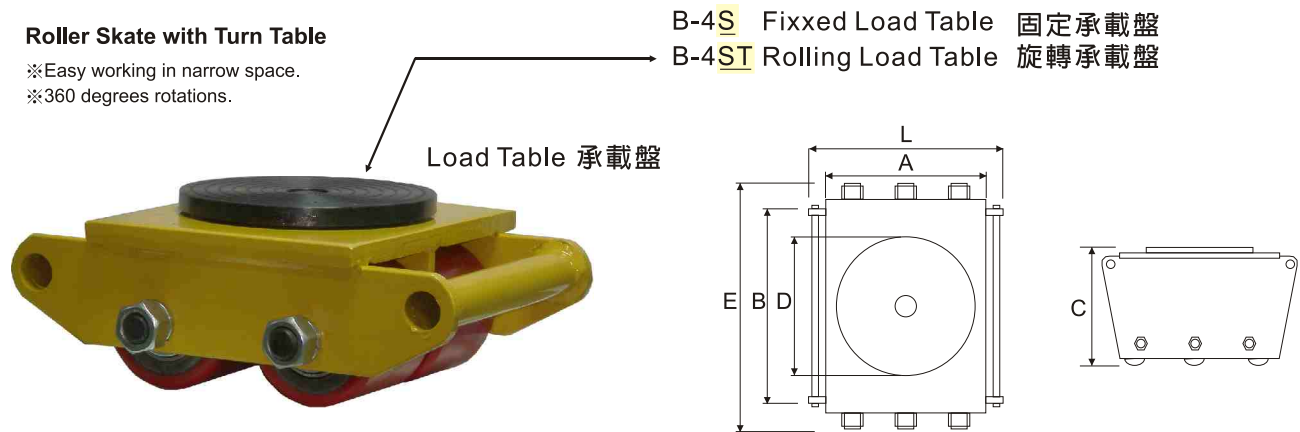

Model Number 型號	Capacity 荷重 (ton)	Style 樣式	Dimension 尺寸 (mm)						Weight 重量 (kg)
			A	B	C	D	E	L	
B-4S	6	Pu 4wheel	170	198	110	150	218	287	15
B-4ST	6	Pu 4wheel	170	198	110	150	218	287	15
B-6S	8	Pu 6wheel	265	198	110	150	218	287	21
B-6ST	8	Pu 6wheel	265	198	110	150	218	287	21
B-8S	12	Pu 8wheel	360	198	110	150	222	477	28
B-8ST	12	Pu 8wheel	360	198	110	150	222	477	28

JO 培林撬棒

Bearing wrecking bar

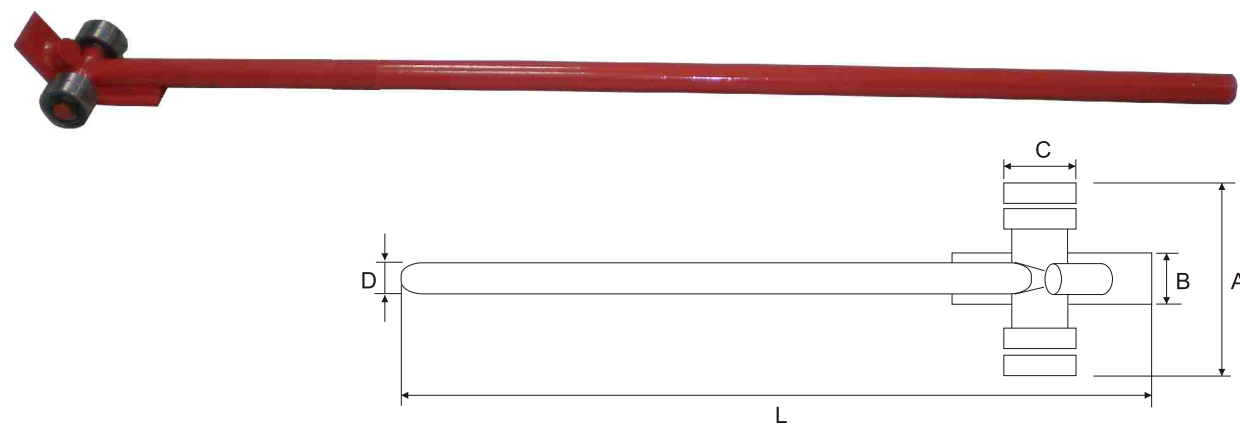

Model Number 型號	Capacity 荷重 (ton)	Dimension 尺寸 (mm)					Weight 重量 (kg)
		A	B	C	D	L	
JO-3	3	150	65	62	34	1430	6.8
JO-5	5	165	75	72	38	1580	12.0

80% Manufacturer's rating of load and stroke are maximum safe limits.
Best using situation is 80% of these ratings!

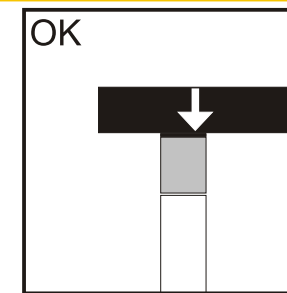
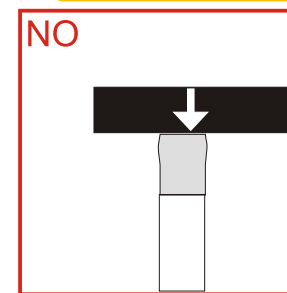

Don't use cylinder without saddle. This will cause plunger to "mushroom". Saddle distribute load evenly on the plunger.

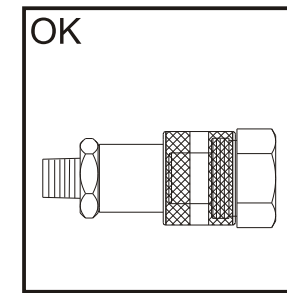
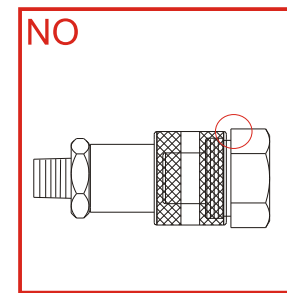

When making connections with quick couplers, make sure the couplings are fully engaged. Threaded connections such as fittings, gauges, etc. must be securely tightened and leak free. Never use excessive tightening force that may distort the fittings or strip the thread profile.

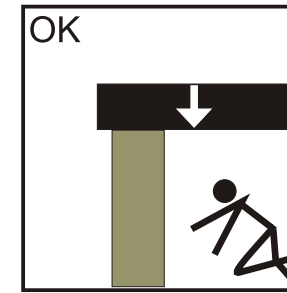
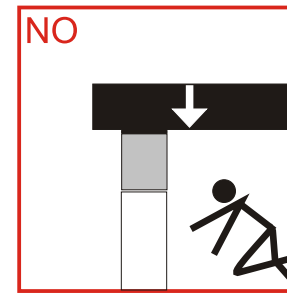

As with jacks, never place any part of your body under the load. Load must be on cribbing before venturing under.

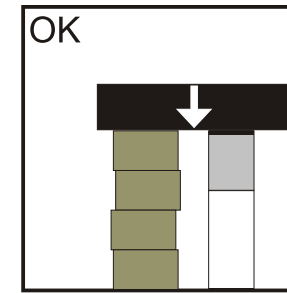
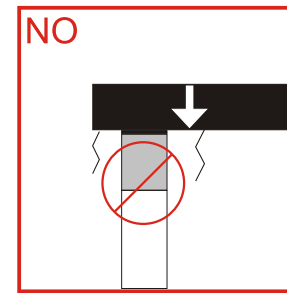

Place blocking or cribbing under the loads as you raise it. Each time you raise it higher, insert more blocking. Position yourself in a manner that will keep you clear of the load, and will not allow your hands or other body part between the load and the cribbing.

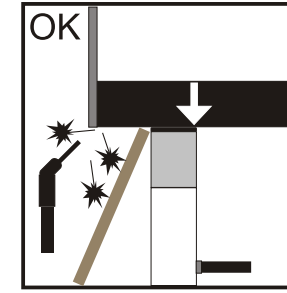
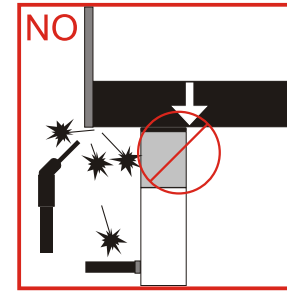

Weld splatter will damage plunger rods and hose. Hydraulic fluid can ignite if vaporized or exposed to high temperatures.

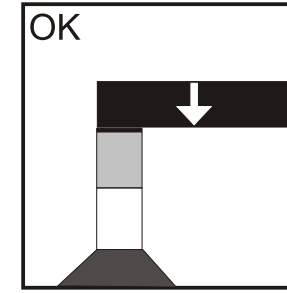
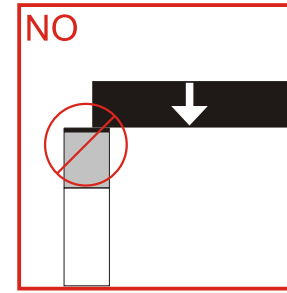

The load must be centered on the ram, or equally distributed on multiple rams. Off center loading can result in the ram slipping out and loss of the load.